

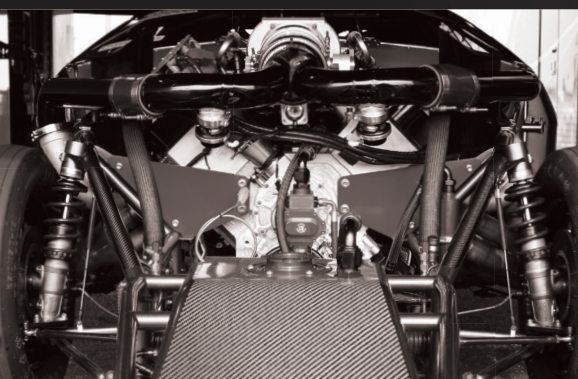

FuelTech



PRO WIRING HARNESS

Plug and Play
FT500 Harness

Installation and
Operation Guide

1. Index

2.	Presentation.....	4
3.	Warranty terms	5
4.	Specifications:	6
5.	Overview	7
	5.1 PRO16 Wiring harness.....	7
	5.2 PRO500 Wiring harness	7
6.	Versions and components.....	7
	6.1 PRO16 components	7
	6.2 PRO500 components.....	9
7.	Labels	9
8.	Diagrams.....	10
	8.1 PRO16 diagrams.....	10
	8.2 Main (37-way CPC connector).....	12
	8.3 Outputs (24-way CPC connector)	12
	8.4 PRO500 diagrams	13
9.	Connectors.....	15
	9.1 Firewall circular connector.....	15
	9.2 Relay and fuses	15
	9.3 Crank trigger and cam sync sensor	15
	9.4 CAN connectors	16
	9.5 TPS	16
	9.6 H2O and air temperature	16
	9.7 Oil and fuel pressure	16
	9.8 Points.....	16
	9.9 MSD legacy (PRO16 only)	16
	9.10 Injectors.....	17
	9.11 Back pressure.....	17
	9.12 Extra connector.....	17
	9.13 Outputs connector (PRO500 only).....	18
10.	Standard sensors.....	18
	10.1 Fuel and oil pressure	18
	10.2 Intake air temperature.....	18
	10.3 Engine temperature.....	18
	10.4 NTK wideband O2 sensor.....	19
	10.5 Bosch LSU 4.2 Wideband O2 Sensor.....	19
11.	O2 Reading.....	19
	11.1 PRO500 - FuelTech WB-O2 Nano.....	19
	11.2 PRO16 – Alcohol O2	19
12.	Peak and Hold - external injector driver	20
13.	Troubleshooting	20

2. Presentation

The FuelTech PRO Wiring Harness is the proper link between the FuelTech FT500 ECU and all of your sensors and actuators.

This equipment has all the components needed to make a plug 'n play installation on most engines. It has all the relays and fuses needed for the system on a standard setup, a firewall connector to make it easier to remove and every connector has its own label.

The insulation and connectors are humidity, heat and oil resistant.

There are two different harness versions depending on the application. An 8 injector version (PRO500 harness), which is setup for the FuelTech WB-O2 Nano reader and is to be used with ethanol, gasoline and low boost alcohol applications. The 16 injector version (PRO16 harness), which accommodates the FuelTech Alcohol O2 module and is used for high boost alcohol applications.

When using the PRO500 harness on high boost applications, adapters for FuelTech Alcohol O2 readers and NTK sensors are available and sold separately.

3. Warranty terms

The use of this equipment implies the total accordance with the terms described in this manual and exempts the manufacturer from any responsibility regarding to product misuse.

Read all the information in this manual before starting the product installation.

This product must be installed and tuned by specialized auto shops and/or personnel with experience on engine tuning.

Before starting any electric installation, disconnect the battery.

The inobservance of any of the warnings or precautions described in this manual might cause engine damage and lead to the invalidation of this product warranty. The improper adjustment of the product might cause engine damage.

This product does not have a certification for the use on aircrafts or any flying devices, as it has not been designed for such use purpose.

In some countries where an annual inspection of vehicles is enforced, no modification in the OEM ECU is permitted. Be informed about local laws and regulations prior to the product installation.

Limited warranty

All products manufactured by FUELTECH are warranted to be free from defects in material and workmanship for one year following the date of original purchase. Warranty claim must be made by original owner with proof of purchase from authorized reseller. This warranty does not include sensors or other products that FUELTECH carries but did not manufacture. If a product is found defective, such products will, at FUELTECH's option, be replaced or repaired at cost to FUELTECH. All products alleged by Purchaser to be defective must be returned to FUELTECH, postage prepaid, within one year warranty period.

This limited warranty does not cover labor or other costs or expenses incidental to the repair and/or replacement of products or parts. This limited warranty does not apply to any product which has been subject to misuse, mishandling, misapplication, neglect (including but not limited to improper maintenance), accident, improper installation, tampered seal, modification (including but not limited to use of unauthorized parts or attachments), or adjustment or repair performed by anyone other than FUELTECH.

The parties hereto expressly agree that the purchaser's sole and exclusive remedy against FUELTECH shall be for the repair or replacement of the defective product as provided in this limited warranty. This exclusive remedy shall not be deemed to have failed of its essential purpose so long as FUELTECH is willing and able to repair or replace defective goods.

FUELTECH reserves the right to request additional information such as, but not limited to, tune up and log files in order to evaluate a claim. Seal violation voids warranty and renders loss of access to upgrade releases.

Manual version 1.3 – Jun/2017

4. Specifications:

PRO500 harness

- 8 injector outputs;
- 2 FuelTech Peak and Hold external drivers ready;
- Dual FuelTech WB-Nano O2 ready;
- Bosch LSU 4.2 O2 sensors ready;
- FuelTech CAN network connectors (male and female);
- GM Style intake air temperature sensor ready;
- GM Style engine temperature sensor ready;
- 3 pressure sensor ready for fuel, oil and backpressure/
another 0-5V sensor;
- High output relays with integrated fuse holders;
- Humidity, heat and oil resistant;
- Extra connector with 4 inputs and 4 outputs for generic
use;
- Outputs connector with 8 ignition outputs can be used
to build a coil on plug harness;

PRO16 Harness

- 16 injector outputs;
- 4 FuelTech Peak and Hold external drivers ready;
- FuelTech Alcohol O2 dual channel ready;
- NTK O2 sensors ready;
- FuelTech CAN network connectors (male and female);
- GM Style intake air temperature sensor ready;
- GM Style engine temperature sensor ready;
- 3 pressure sensor ready for fuel, oil and backpressure/
another 0-5V sensor;
- High output sealed relays with sealed fuse holders;
- Humidity, heat and oil resistant;
- Extra connector with 4 inputs and 4 outputs for generic
use;

Dimensions (in package):

- 20" x 20" x 5"

Weight:

- 7.16 lbs. for PRO500
- 8.5 lbs. for PRO16

5. Overview

The FuelTech PRO Wiring Harness is a complete plug n' play wiring solution to be used with a FuelTech FT500 ECU. It has all the connectors, relays and fuses directly built-in and can be used with nearly any application up to 16 injectors.

5.1 PRO16 Wiring harness

The PRO16 is a FuelTech FT500 harness designed for systems with 16 staged injectors (dual banks), distributor and FuelTech Alcohol O2 dual channel (1.9 AFR) to run sequential, semi-sequential or multipoint injection. It is already wired for 4 FuelTech Peak and Hold drivers for setups utilizing low impedance injectors. When using high impedance injectors, Peak and Holds are not needed. In this case, only a bypass connector (jumper wires sold separately) is required.

There are 3 relays to power the complete system, separating the injectors from the electronics.



5.2 PRO500 Wiring harness

The PRO500 is a harness designed for systems with 8 injectors, distributor and dual channel WB-O2 Nano with Bosch LSU 4.2 sensors to run sequential, semi-sequential or multipoint fuel injection. It is ready for 2 FuelTech Peak and Hold drivers for setups utilizing low impedance injectors. When using high impedance injectors, Peak and Holds are not needed. In this case, only a bypass connector (jumper wires sold separately) is required.

There are 2 relays to power the complete system, separating the injectors from the electronics.

This harness also allows running COP coils (sequential or wasted spark ignition) or PRO-Nitrous setup through the Outputs connector, which has 8 generic purpose outputs.

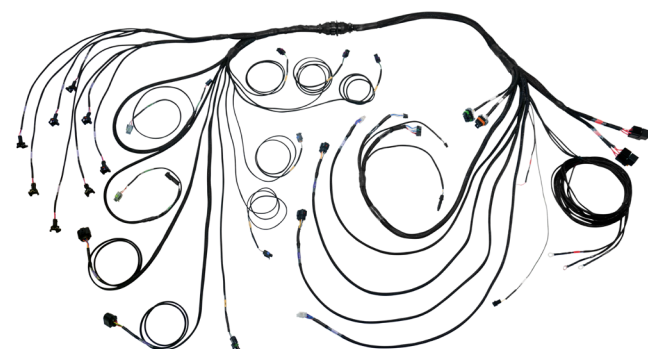

6. Versions and components

To make it easier to install and to do the service in the car/engine, the PRO Wiring Harness is modular, so you can disconnect the engine side of the harness from the rest of it. Below are all of the parts contained in each version:

6.1 PRO16 components

Main/Outputs (inner)

This is the section that will be installed in the inner side of the car. In this side you will find the connections to all the units, the wires related to the power supply (+12V to battery, ground to battery, ground to chassis, +12V switched), relays and fuses. Check below to see all of the connectors and where they are connected:

- **FuelTech FT500 main and auxiliary**
Direct connection to FT500, both connectors must be securely installed.
- **4x FuelTech Peak and Hold**
These are the driver boxes needed to fire low impedance injectors. When the system uses high impedance injectors, jumper wires are required (sold separately). If the Peak and Hold or the jumper wires are not being used, the injectors will not fire.
- **FuelTech Alcohol O2 dual channel**
This connector goes to the FuelTech Alcohol O2 module, the wideband O2 sensor conditioner designed to read extremely rich AFRs.
- **3x 40A Relay**
The system has 3 relays to power everything. The Main Relay powers the ECU, Alcohol O2, Peak and Hold drivers and sensors. The Outputs (Primary) Relay powers the primary injectors and the Outputs (Secondary) Relay powers the secondary injectors.
- **+12V Switched wire**
This wire goes to the ignition switch and is responsible for turning on all the relays.
- **Power ground, battery ground and battery positive**
It is the system power supply and must be connected exactly as the following: Battery (+) goes direct to the battery's positive or kill switch. Battery (-) MUST GO ONLY to the battery's negative terminal. Power ground goes to the engine or chassis.
- **Extra connector with generic inputs and outputs (including Points and MSD Legacy)**
Since FT500 has 20 outputs and 11 inputs, all the unused outputs and inputs are wired in the Extra connector to make easier to wire it for other functions

such as a nitrous system or a travel height sensor. The inputs to transbrake and driveshaft RPM sensor must be picked up from this connector.

- **Main Inner 37-way circular**

The Main connector is a 37-way Tyco CPC connector which contains all necessary inputs to run an engine. This connector can be attached to the firewall.

- **Outputs Inner 24-way circular**

The Outputs connector has all the injectors outputs. There are 8 injectors outputs in each bank. This connector can be attached to the firewall.



Main (engine)

- **Female 37-way circular connector**

The Main connector is a 37-way Tyco CPC connector which contains all necessary inputs to run an engine. There you will find the following connectors: O2 sensors, Crank Trigger Sensor, Cam Sync Sensor, TPS, Oil Pressure, Fuel Pressure, Points, MSD Legacy, Engine Temperature, Intake Air Temperature, Back Pressure or any 0-5V sensor.

- **Throttle position sensor**

The TPS measures the throttle position. The PRO harness has a 3-way Weather Pack connector and almost any 0-5V TPS can be used.

- **Back pressure sensor**

This input can be used to read the back pressure, any other pressure with a FuelTech PS sensor or any 0-5V sensor. It also can read an external MAP sensor.

- **Points (ignition output)**

Points is the ignition output to fire a MSD ignition box or other ignition modules in a distributor system.

- **Fuel pressure sensor**

This input can be used to read fuel pressure using a FuelTech PS sensor or SSI P51 Packard sensor.

- **Oil pressure sensor**

This input can be used to read oil pressure using a FuelTech PS sensor or SSI P51 Packard sensor.

- **Crank trigger sensor (Hall effect or variable reluctance)**

PRO harness is ready for both MSD crank trigger (VR) and Cherry GS101201 Hall effect sensor.

- **Cam sync sensor (Hall effect or variable reluctance)**

PRO16 harness is ready for both Pro Mag 44 trigger (with mods) and Cherry GS101201 Hall effect sensor.

- **Engine temperature sensor**

Ready for GM style CLT sensor.

FuelTech 5005100015 or GM 25036751

- **Intake air temperature sensor**

Ready for GM style IAT sensor.

FuelTech 5005100015 or GM 25036751

- **MSD Legacy output (Ignition cut)**

This output performs ignitions cuts using the MSD Legacy port existing in MSD 6/7/8 and Pro Mag 44 points box.

- **2x NTK wideband sensors**

Designed for NTK Alcohol O2 sensors.



Outputs (engine)

- **8x fuel injectors outputs (primary bank)**

8 injectors outputs (EV1 connector) which allows sequential fuel injection and individual fuel cylinder trim.

- **8x fuel injectors outputs (secondary bank)**

8 injectors outputs (EV1 connector) which allows sequential fuel injection and individual fuel cylinder trim.



6.2 PRO500 components

Main inner

This is the part that will be installed in the inner side of the car. In this part you will find the connections to all the units, the wires related to the power supply (+12V to battery, ground to battery, +12V switched), relays and fuses. Check below to see all of the connectors and where they are connected:

- **FuelTech FT500 main and auxiliary**
Direct connection to the FT500, both connectors must be securely installed.
- **2x FuelTech Peak and Hold**
These are the driver boxes needed to fire low impedance injectors. When using high impedance injectors, jumper wires are required (sold separately). If the Peak and Hold or the jumper wires are not being used, the injectors will not fire.
- **FuelTech WB-O2 Nano**
This connector goes to FuelTech WB-O2 Nano module, a Bosch LSU 4.2 O2 sensor conditioner.
- **2x 40A Relay**
The system has 2 relays to power everything. The Main Relay powers the ECU, WB-O2 Nano, Peak and Hold drivers and sensors. The Injectors Relay powers the injectors.
- **+12V Switched wire**
This wire goes to the ignition switch and is responsible for turning on all the relays.
- **Power ground, battery ground and battery positive**
It is the system power supply and must be connected exactly as the following: Battery (+) goes direct to the battery's positive or kill switch. Battery (-) MUST GO ONLY to the battery's negative terminal. Power ground goes to the negative battery.

- **Extra connector with generic inputs and outputs (including Points)**

Since FT500 has 20 outputs and 11 inputs, all the unused outputs and inputs (except gray wires) are wired in the Extra connector to make easier to wire it for other functions such as a nitrous system or a travel height sensor. The inputs to transbrake and driveshaft RPM sensor must be picked up from this connector.

- **Main Inner 37-way circular**

The Main connector is a 37-way Tyco CPC connector which contains all necessary inputs and outputs to run an engine.

This connector can be attached to the firewall.

- **Outputs connector**

The Outputs connector has all the gray outputs, which can be used to run COP coils, nitrous systems or other auxiliary functions.



7. Labels

All connectors have proper labels to identify each one. They're labeled by color and description name. The colors are related to its functions:

Green – The green labels are related to the RPM sensors (Crank Trigger and Cam Sync)

Yellow – Input sensors such as TPS, Engine Temp, Air temp, Fuel Pressure, Oil Pressure, Back Pressure or any other 0-5V sensor

Blue – Exclusively to O2 sensors (NTK or Bosch)

White – Outputs and Extra connector, Points, MSD Legacy

Purple – Peak and Hold and fuel injectors (Primary bank)

Brown – Peak and Hold and fuel injectors (Secondary bank)

Black – FT500, Main

8. Diagrams

8.1 PRO16 diagrams

Inputs/outputs

Wire color	Pin	Connector	Function
Blue #1	24	Main	Primary #1 injector
Blue #2	23	Main	Primary #2 injector
Blue #3	13	Main	Primary #3 injector
Blue #4	6	Auxiliary	Primary #4 injector
Blue #5	8	Auxiliary	Primary #5 injector
Blue #6	2	Main	Primary #6 injector
Blue #7	4	Main	Primary #7 injector
Blue #8	6	Main	Primary #8 injector
White #1	1	Auxiliary	Left O2 sensor input
White #2	5	Auxiliary	Back pressure input
White #3	7	Auxiliary	Right O2 sensor input
White #4	9	Main	Oil pressure input
White #5	7	Main	Engine temperature input
White #6	5	Main	Fuel pressure input
White #7	3	Main	Air temperature input
White #8	12	Auxiliary	Generic input: pin G of EXTRA connector
White #9	10	Auxiliary	Generic input: pin H of EXTRA connector
White #10	3	Auxiliary	MSD Legacy cut/Generic output: pin J of EXTRA connector
White #11	11	Main	TPS input
Gray #1	18	Main	Secondary #1 injector
Gray #2	16	Main	Secondary #2 injector
Gray #3	14	Main	Secondary #3 injector
Gray #4	12	Main	Secondary #4 injector
Gray #5	10	Main	Secondary #5 injector
Gray #6	2	Auxiliary	Secondary #6 injector
Gray #7	4	Auxiliary	Secondary #7 injector
Gray #8	1	Main	Secondary #8 injector
Yellow #1	13	Auxiliary	Points/Generic output: pin A of EXTRA connector
Yellow #2	14	Auxiliary	Generic output: pin B of EXTRA connector
Yellow #3	15	Auxiliary	Generic output: pin C of EXTRA connector
Yellow #4	16	Auxiliary	Generic output: pin D of EXTRA connector

FT500 rear connectors – Main - PRO16

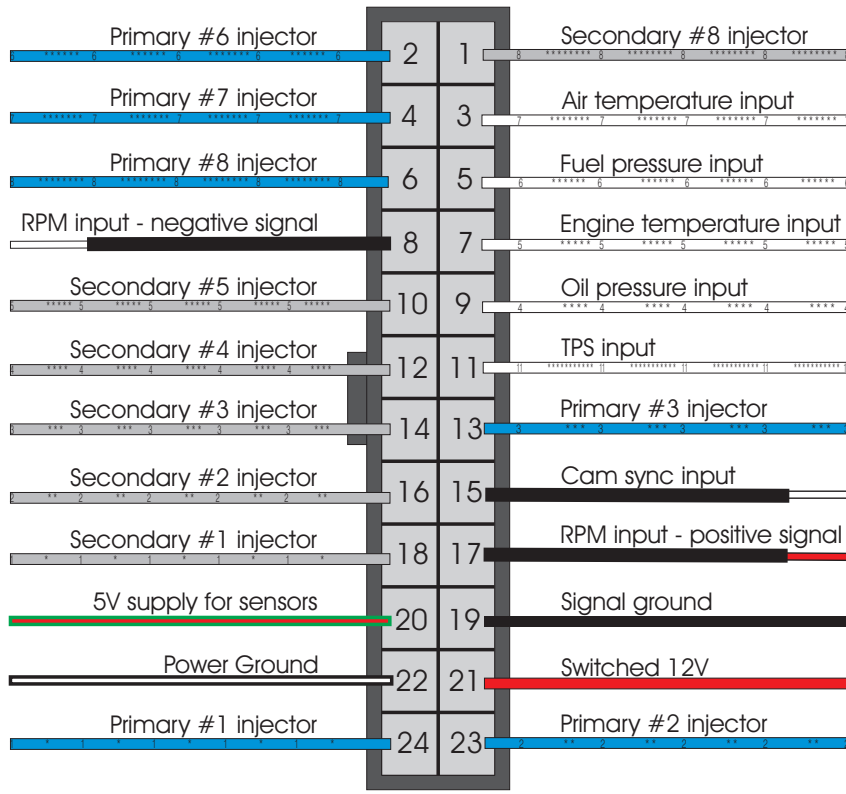

24-way connector rear view

FT500 rear connectors - Auxiliary - PRO16

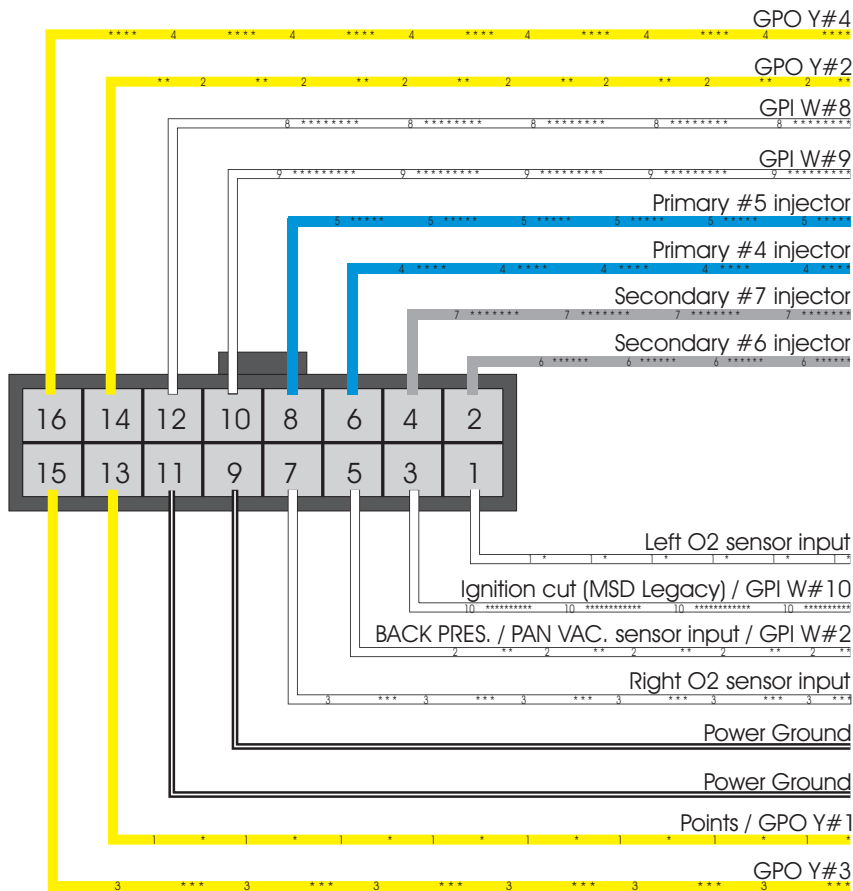

16-way connector rear view

8.2 Main (37-way CPC connector)

37-way CPC connector 16 injectors – Main		
Pin	Wire color	Function
1	White 7	Air temperature input
2	White 6	Fuel pressure input
3	White 5	Engine temperature input
4	White - Shielded cable - crank	RPM input - negative signal
5	White 4	Oil pressure input
6	White 11	TPS input
7	White - Shielded cable - cam	Cam sync input
8	Red - Shielded cable - crank	RPM input - positive signal
9	Green/Red	5V supply for sensors
10	White 2	Back pressure sensor input
11	Yellow 1	Points
12	White 10	Ignition cut (MSD Legacy)
13	Red	Pin 87 Main relay - 12V to electronics
14	Black	Battery (-) - Signal ground
15	Black	Battery (-) - Signal ground
26	Blue	Pin #1 - O2 sensor #2 Right
27	Yellow	Pin #2 - O2 sensor #2 Right
28	White	Pin #7 - O2 sensor #2 Right
29	Gray	Pin #6 - O2 sensor #2 Right
30	Brown	Pin #8 - O2 sensor #2 Right
31	Gray	Pin #6 - O2 sensor #1 Left
32	Brown	Pin #8 - O2 sensor #1 Left
33	Blue	Pin #1 - O2 sensor #1 Left
34	Yellow	Pin #2 - O2 sensor #1 Left
35	White	Pin #7 - O2 sensor #1 Left

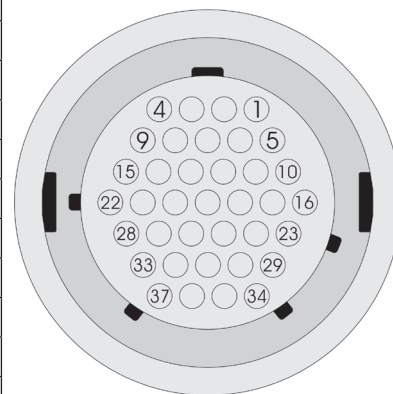

37-way CPC connector - Front view

8.3 Outputs (24-way CPC connector)

24-way CPC connector 16 injectors – Outputs		
Pin	Wire color	Function
1	Purple	Primary #1 injector
2	Purple	Primary #2 injector
3	Purple	Primary #3 injector
4	Purple	Primary #4 injector
5	Purple	Primary #5 injector
6	Purple	Primary #6 injector
7	Purple	Primary #7 injector
8	Purple	Primary #8 injector
9	Brown	Secondary #1 injector
10	Brown	Secondary #2 injector
11	Brown	Secondary #3 injector
12	Brown	Secondary #4 injector
13	Brown	Secondary #5 injector
14	Brown	Secondary #6 injector
15	Brown	Secondary #7 injector
16	Brown	Secondary #8 injector
17	Red	Pin 87 Outputs (Primary) Relay - 12V to 1P, 3P, 5P, 7P
18	Red	Pin 87 Outputs (Primary) Relay - 12V to 2P, 4P, 6P, 8P
19	Red	Pin 87 Outputs (Secondary) Relay - 12V to 1S, 3S, 5S, 7S
20	Red	Pin 87 Outputs (Secondary) Relay - 12V to 2S, 4S, 6S, 8S

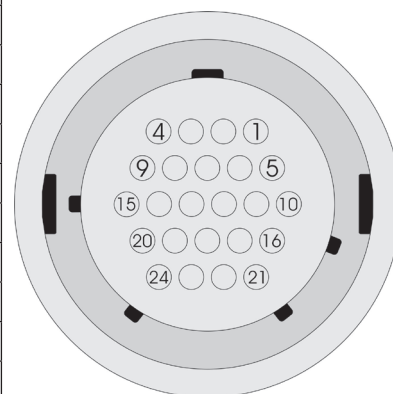

24-way CPC connector - Front view

8.4 PRO500 diagrams

Inputs/outputs

Wire color	Pin	Connector	Function
Blue #1	24	Main	#1 injector
Blue #2	23	Main	#2 injector
Blue #3	13	Main	#3 injector
Blue #4	6	Auxiliary	#4 injector
Blue #5	8	Auxiliary	#5 injector
Blue #6	2	Main	#6 injector
Blue #7	4	Main	#7 injector
Blue #8	6	Main	#8 injector
White #1	1	Auxiliary	Left O2 sensor input
White #2	5	Auxiliary	Back pressure input
White #3	7	Auxiliary	Right O2 sensor input
White #4	9	Main	Oil pressure input
White #5	7	Main	Engine temperature input
White #6	5	Main	Fuel pressure input
White #7	3	Main	Air temperature input
White #8	12	Auxiliary	Generic input: pin G of EXTRA connector
White #9	10	Auxiliary	Generic input: pin H of EXTRA connector
White #10	3	Auxiliary	Generic output: pin J of EXTRA connector
White #11	11	Main	TPS input
Gray #1	18	Main	Generic output: pin A of OUTPUTS connector
Gray #2	16	Main	Generic output: pin B of OUTPUTS connector
Gray #3	14	Main	Generic output: pin C of OUTPUTS connector
Gray #4	12	Main	Generic output: pin D of OUTPUTS connector
Gray #5	10	Main	Generic output: pin E of OUTPUTS connector
Gray #6	2	Auxiliary	Generic output: pin F of OUTPUTS connector
Gray #7	4	Auxiliary	Generic output: pin G of OUTPUTS connector
Gray #8	1	Main	Generic output: pin H of OUTPUTS connector
Yellow #1	13	Auxiliary	Points/Generic output: pin A of EXTRA connector
Yellow #2	14	Auxiliary	Generic output: pin B of EXTRA connector
Yellow #3	15	Auxiliary	Generic output: pin C of EXTRA connector
Yellow #4	16	Auxiliary	Generic output: pin D of EXTRA connector

FT500 rear connector - Main - PRO500

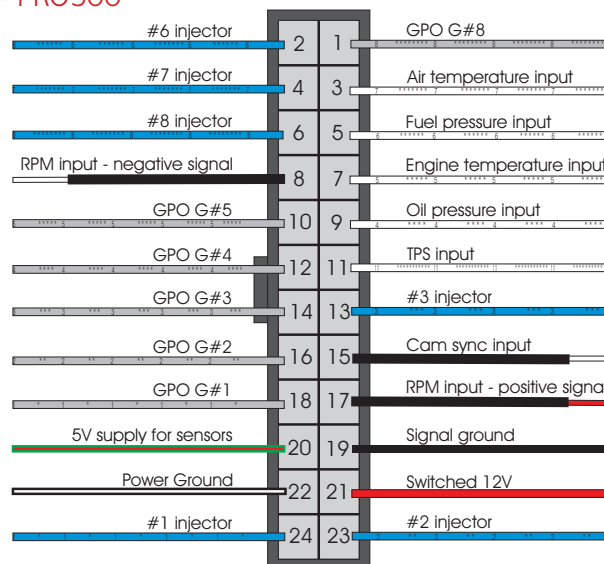

24-way connector rear view

FT500 rear connector - Auxiliary - PRO500

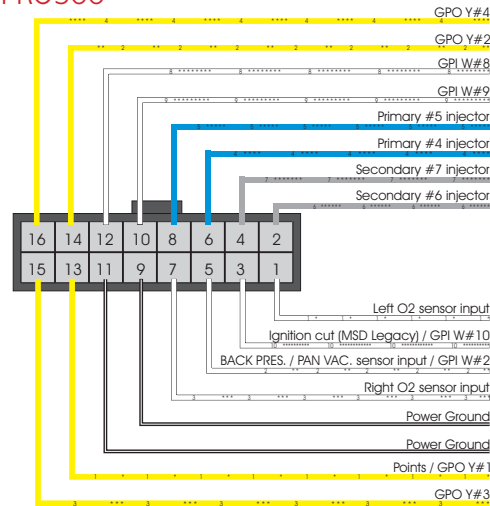

16-way connector rear view

37-way CPC connector 8 injectors – Main

Pin	Wire color	Function
1	White 7	Air temperature input
2	White 6	Fuel pressure input
3	White 5	Engine temperature input
4	White - Shielded cable - crank	RPM input - negative signal
5	White 4	Oil pressure input
6	White 11	TPS input
7	White - Shielded cable - cam	Cam sync input
8	Red - Shielded cable - crank	RPM input - positive signal
9	Green/Red	5V supply for sensors
10	White 2	Back pressure sensor input
13	Red	Pin #87 Main relay - 12V to electronics
14	Black	Battery (-) - Signal ground
15	Black	Battery (-) - Signal ground
16	Purple	Peak and Hold (L) - #1 injector
17	Purple	Peak and Hold (L) - #3 injector
18	Purple	Peak and Hold (L) - #5 injector
19	Purple	Peak and Hold (L) - #7 injector
20	Purple	Peak and Hold (R) - #2 injector
21	Purple	Peak and Hold (R) - #4 injector
22	Purple	Peak and Hold (R) - #6 injector
23	Purple	Peak and Hold (R) - #8 injector
24	Red	Pin #87 Injectors Relay - 12V injectors
25	Red	Pin #87 Injectors Relay - 12V injectors
26	Blue	Pin #1 - WBO2 sensor #1 Left
27	Brown	Pin #2 - WBO2 sensor #1 Left
28	Green	Pin #3 - WBO2 sensor #1 Left
29	Yellow	Pin #4 - WBO2 sensor #1 Left
30	Orange	Pin #5 - WBO2 sensor #1 Left
31	Red	Pin #6 - WBO2 sensor #1 Left
32	Blue	Pin #1 - WBO2 sensor #2 Right
33	Brown	Pin #2 - WBO2 sensor #2 Right
34	Green	Pin #3 - WBO2 sensor #2 Right
35	Yellow	Pin #4 - WBO2 sensor #2 Right
36	Orange	Pin #5 - WBO2 sensor #2 Right
37	Red	Pin #6 - WBO2 sensor #2 Right

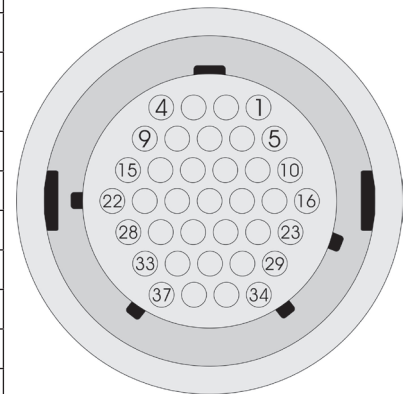

37-way CPC connector - Front view

9. Connectors

9.1 Firewall circular connector

The CPC connector is both safe and user friendly and offers the perfect connection solution for the harness through the firewall, by having keys that don't allow connecting in the wrong position. There is one 37-way and one 24-way in the PRO16 and one 37-way in the PRO500.



9.2 Relay and fuses

PRO16

The relays available in the PRO16 Harness are automotive sealed heavy duty type. The relay max current is 40A followed by a 40A fuse. There is a main relay for the FuelTech units such as ECU, O2 conditioner and 2 other relays for the fuel injectors (one relay per fuel bank).



PRO500

The relays on the PRO500 are heavy duty 40A with integrated fuse holders - 40Amps fuse equipped.



9.3 Crank trigger and cam sync sensor

The PRO harness is ready to run MSD 8276 and Cherry GS101201 sensor for the crank trigger. For the cam sync sensor, the PRO16 is designed to read the trigger contained in the Pro Mag 44 magneto. The PRO500 version is ready to run the MSD 2346 cam sync kit.

Crank trigger

When using MSD 8276 as crank trigger, be sure that the violet wire from the sensor goes to the red wire of Crank VR connector and the green wire from the sensor goes to the black wire of Crank VR connector. If for any reason the

sensor is not wired like this, swap the wires to match and connect like the above.

The Crank VR connector is a MSD 8824 and Crank Hall is a 3-way Metri-Pack 150.2.

Sensor	Sensor pin/wire	Harness wire
Cherry GS101201	A	12V
	B	Red wire from Crank Hall
	C	Battery's negative
MSD 8276	Purple	Red wire from Crank VR
	Green	White wire from Crank VR
MSD 8154	Red	Red wire from Crank VR
	Black	White wire from Crank VR
Electrimotion	1	White wire from Crank VR
	2	Red wire from Crank VR

Cam sync sensor

For the Cam Sync sensor, the PRO16 is meant to use the modified Pro Mag 44 trigger (must modify the trigger, contact FuelTech tech support for further information) or the same Cherry GS101201 used as crank trigger.

When using Pro Mag 44 trigger, be sure the black/orange wire from the trigger goes to the white wire from Cam VR and the black/purple goes to the black wire from Cam VR. If for any reason the sensor is not wired like this, swap the wires to match and connect like above.

The PRO500 is made to read the MSD 2346 Cam Sync kit and Cherry GS101201. With MSD 2346, the purple wire must go to the white wire from Cam VR and the green wire must go to the black wire from Cam VR. If for any reason the sensor is not wired like this, swap the wires to match and connect like above.

The Crank VR connector is a MSD 8824 in the PRO16, 2-way Weather-Pack in the PRO500 and Crank Hall is a 3-way Metri-Pack 150.2 in both.

Sensor	Sensor Pin/Wire	Harness wire
Cherry GS101201	A	12V
	B	Red wire from Crank Hall
	C	Battery's negative
MSD 2346	Purple	Red wire from Crank VR
	Green	Battery's negative
Pro Mag 44	Black/Orange	Red wire from Crank VR
	Black/Purple	White wire from Crank VR
Electrimotion	1	White wire from Crank VR
	2	Red wire from Crank VR

9.4 CAN connectors

The PRO harnesses are plug and play for FuelTech CAN Network, featuring a male connector that is meant to be plugged on the back of the FT500 ECU, allowing data reading from the dual WB-O2 Nanos. There's also a female connector used to expand the CAN network for more Nanos or other FuelTech equipment. When the CAN female is not used, keep the CAN terminator resistor plugged in.



9.5 TPS

TPS is a potentiometer that informs the throttle position. FT500 can read almost any 0-5V TPS. The PRO harness uses a 3-way male Weather Pack connector.

Pin A: signal ground; Pin B: 5V supply; Pin C: signal output.



9.6 H2O and air temperature

The PRO Wiring Harness has 2 temperature inputs. One input is for the engine temperature (H2O) and the other is for the intake air temperature (AIR). Both sensors are GM style and uses Metri-Pack 150.2 connectors.

Pin A: signal output; pin B: battery's negative.



9.7 Oil and fuel pressure

The oil and fuel pressure sensor connector are designed for the PS-150, PS-300 and PS-1500 sensors; ranging from 150 to 1500 psi, with a Packard style 3-way connector. It has a 5V ground and signal.

Pin A: battery's negative (black); pin B: 5V supply (green/red); pin C: signal output (white).



9.8 Points

The points wire is the ignition output when using a distributor based capacitive ignition (like MSD 6/7/8 or Pro Mag 44). The points output is connected to the points input of the ignition box (white wire of MSD 6/7/8 or purple wire of Pro Mag 44).

When using a MSD Grid, the FT500 points output must be connected to the points input on the MSD Grid.



9.9 MSD legacy (PRO16 only)

The ignition cut output, also called MSD Legacy output, is connected to the white #10 input and it drives the ignition cut for MSD boxes like 7/8 Series and Pro Mag 44. Without this connection, the rev limiter will be erratic.

MSD Legacy must be connected to the MSD ignition box RPM modules input (aka Legacy, pills), replacing the RPM module for an ignition cut controlled by FuelTech FT500.

Check below to see in what port MSD Legacy wire must be connected in different ignition boxes:

- MSD 7AL2 goes to RPM port
- MSD 7AL2 Plus goes to Module 2 port
- MSD 7AL3 goes to RACE port
- MSD 8 Plus goes to Module 2 port
- MSD Pro Mag 44 points box goes to the RPM module port

MSD Power Grid 7 (PN 7720) doesn't use MSD Legacy wire, the ignition cut is made by points.

When using the MSD Grid (PN 7730) ignition controller, it remains disconnected.

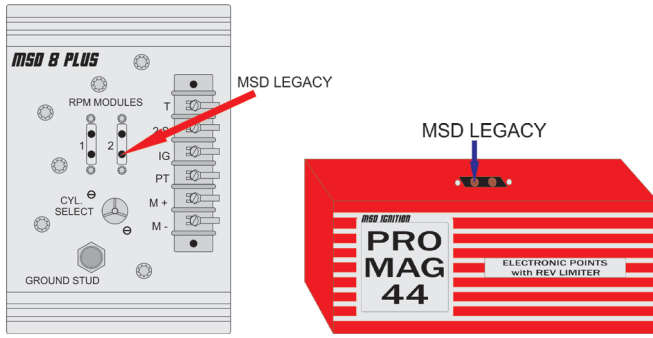

Extra pinout	
Connector pin	FT500 output
A	Yellow 1
B	Yellow 2
C	Yellow 3
D	Yellow 4
E	5V supply
F	White 3
G	White 8
H	White 9
J	White 10
K	White 1

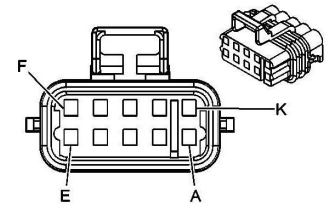

9.10 Injectors

In the PRO16 version there are 16 injector outputs available divided in 2 banks, primary and secondary. Primary is labeled in purple color and secondary in brown color. In the PRO500 there's 8 injector outputs always labeled in purple. All injectors connectors are Bosch EV1 style.



Yellow outputs are the most specialized outputs. They are HALF BRIDGE or PUSH PULL type outputs. This means that they can feed 5A both by negative or positive side. They are important and necessary to control Electronic drive-by-wire throttle (DC motors) and stepper motor 4 wire idle control valves. They also can be used to control any type of LO SIDE or HI SIDE actuator (LO SIDE means the ECU will switch ground to activate the device, HI SIDE means the ECU will switch 12V to active the device).

9.11 Back pressure

This is a generic input pressure normally used to read back pressure. It can also be used as a MAP sensor input or any other 0-5V sensor. PRO harness comes with a Delphi Metri-Pack 150 connector and uses the white input #2, which is also available at Extra connector. When the back pressure connector is being used, the white #2 in the Extra connector can't be used.

Pin A: battery's negative (black); pin B: 5V supply (green/red); pin C: signal output (white).

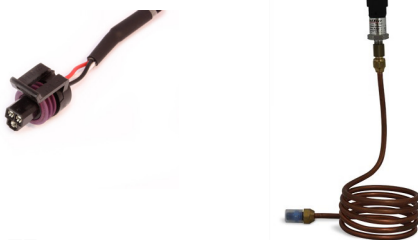

NOTE:
Do not connect the pressure sensor directly to the exhaust manifold. Use a pipe between the sensor and the heat source to prevent overheating.

Since it can feed 12V power at 5A, if wired to a relay activating it by ground (from the FuelTech) when turned off, it senses the 12V through the relay coil and feeds back power to the ECU. In this case, it is necessary to run a series diode (4004 or 4007) like the following schematic to avoid this issue.

Both ways of wiring this output are described in the following diagrams:

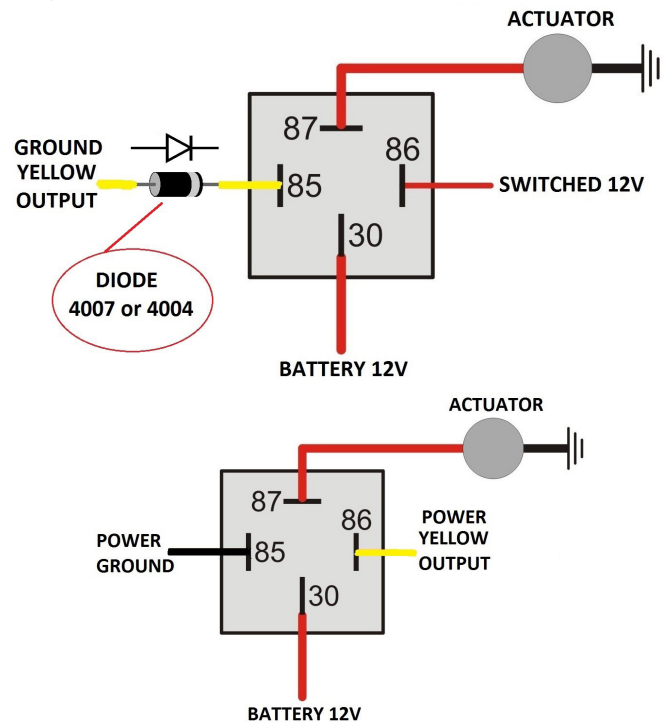

9.12 Extra connector

This connector has 4 generic inputs (white color), 4 generic outputs (yellow color) and a 5v to be used if needed.

There are some relays with a built-in diode, like Hella 003437101.



WARNING:

In the case that the system is used together with a MSD ignition box without MSD Grid, the White #10 and the Yellow #1 that are present in this connector can't be used as an input or output, as this is already being used as "MSD Legacy" and "Points".

9.13 Outputs connector (PRO500 only)

The outputs connector is available only in the PRO500 and has 8 gray outputs for generic use. Gray outputs are the LO SIDE with 5A and HI SIDE with 30mA 5V current source that can be used to drive coils igniter and many other LO SIDE actuators like injectors, relays and solenoids.

Outputs pinout	
Connector pin	FT500 output
A	Gray 1
B	Gray 2
C	Gray 3
D	Gray 4
E	Gray 5
F	Gray 6
G	Gray 7
H	Gray 8

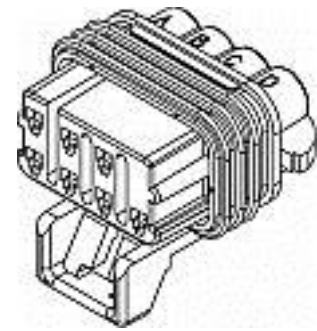

If the system being activated requires a 12v output, the yellow outputs are capable of ground or 12v. If no yellow outputs are available, it's possible to drive a relay by ground with any gray output to get the proper 12v output switched by one of the gray outputs by following this diagram:

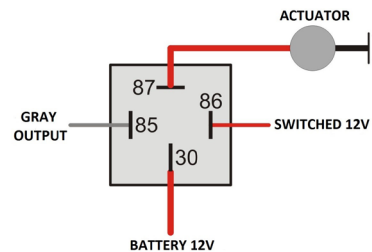

10. Standard sensors

10.1 Fuel and oil pressure

FuelTech PS-150/300/1500 is a high precision sensor responsible for general pressure readings (fuel, oil, boost, exhaust back pressure, etc.)

It can be purchased online at www.fueltech.net or from an authorized FuelTech dealer (check the website to locate the dealer nearest to you).

FuelTech PS-150/300/1500 sensor below:

- Connection: 1/8" - 27NPT
- Pressure Range: 0 to 150/300/1500psi
- Power Voltage: 5V
- Output Scale: 0.5-4.5V
- Electric Connector: 3-way Metri Pack 150
 - Pin 1: Battery's Negative
 - Pin 2: 5V supply
 - Pin 3: Output signal

FuelTech part numbers:

- 5005100020 - 0-150 psi sensor
- 5005100021 - 0-300 psi sensor
- 5005100022 - 0-1500 psi sensor



10.2 Intake air temperature

With this sensor, the ECU can monitor the intake air temperature and perform real time compensations. One of its pins is connected to the battery negative, the other to the white #7 wire.

Part numbers: FuelTech 5005100015 or GM 25036751

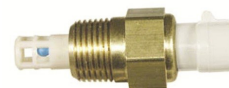

10.3 Engine temperature

This sensor is very important for a good running engine, as varying engine temperatures dramatically affect an engine's fuel and timing requirements.

On water cooled engines, place this sensor near the engine head, reading the water temperature. On air cooled engines, install this sensor in a boss where it can monitor the engine oil temperature. One of its pins is connected to the battery negative, the other to the white #5 wire.

Part numbers: FuelTech 5005100016 or GM 12146312



10.4 NTK wideband O2 sensor

The NTK wideband O2 sensor is the standard O2 sensor to be used with the PRO16 Wiring Harness. This sensor must be used in conjunction with the FuelTech Alcohol O2 module. NTK sensor requires free-air calibration. Check Alcohol O2 manual for further instructions.

To purchase NTK sensor, contact FuelTech.
Part number: FuelTech 5005100011



10.5 Bosch LSU 4.2 Wideband O2 Sensor

Bosch LSU 4.2 is a wideband O2 sensor that can be used with both the WB-O2 Nano (PRO500) and Alcohol O2 (PRO16). When using LSU 4.2 with our Alcohol O2 reader, an adapter harness is required, as well as free air calibration. Check the Alcohol O2 manual for further instructions.

To purchase the adapter harness, contact FuelTech.
Part numbers: FuelTech 3022000965 or Bosch 17014



11. O2 Reading

One of the biggest differences between PRO16 and PRO500 Wiring Harness is related to the O2 reading.

11.1 PRO500 - FuelTech WB-O2 Nano

The WB-O2 Nano has a 12-way connector with 3 wire groups. One of them has the connector for the O2 sensor, the second makes the CAN communication with FT500/FT500LITE and the third is responsible for power and analog output.

By default, the analog output is set to values of 8.7AFR to 16.2AFR Gas, but can be configured to 5.14AFR to 17.6AFR Gas or 9.55 to 19.11AFR or 9.55 to 58.80AFR or yet 9.55 to 146.9AFR (Gas), if necessary. For further information, check FuelTech WB-O2 Nano manual.



11.2 PRO16 – Alcohol O2

The FuelTech Alcohol O2 is a dual channel O2 reader and is designed to read extremely low AFRs, recommended mainly for alcohol engines in drag race application, since it is able to read down to 0.28 lambda (1.80AFR alcohol, 2.52AFR E100 or 4.12AFR gasoline). PRO16 is ready to use NTK sensor and requires free-air calibration. FuelTech Alcohol O2 has an AMP Super Seal connector. For further information, check FuelTech Alcohol O2 manual.



12. Peak and Hold - external injector driver

Peak and Hold drivers are designed to control the current on low impedance injectors. The FuelTech Peak and Hold has 4 outputs and in the PRO Wiring Harness will run one injector per channel.

There are 3 different versions of Peak and Hold available to fire different injectors, according to the resistance of the injector. The only differences between the versions are the peak current and the hold current.

- Considering one injector per channel application:
- 2A/0.5A – Bosch 1600cc, Ford Racing 1600cc
- 4A/1A – Siemens Deka 225lb/hr, Precision 225lb/hr
- 8A/2A – Precision 550lb/hr, Billet Atomizer, Moran

Some earlier Moran injectors require a 4A/1A driver. Contact FuelTech tech support to confirm correct Peak and Hold drivers before purchasing.

When using high impedance injectors without Peak and Hold drivers, jumper wires (sold separately, part number 2001000071) must be connected to the Peak and Hold plugs in the harness. If the jumper wires are not being used then the injectors won't fire since there will be no continuity between the FT500 and injectors.

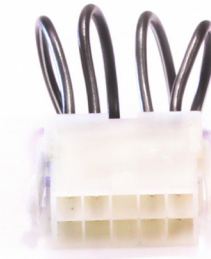

13. Troubleshooting

issue	Solution
FT500 unit doesn't turn on	1. Check battery voltage
	2. Check power and ground cables
	3. Check switched 12V cable
	4. Check ECU harness cables
FT500 doesn't read cranking	1. Check crank trigger and cam sync connections (chapter 7.3)
	2. Check sensor gap
	3. Check diagnostic panel for RPM signal
FT500 reads RPM but engine doesn't start	1. Check if there is spark and injector pulse
	2. Check fuel pressure
	3. Check crank trigger alignment and TPS calibration
	4. Check if outputs are activated and properly configured
	5. Check the O2 sensor reading
Engine runs but doesn't idle	1. Check TPS calibration
	2. Check timing with a timing light
	3. Check TPS idle table and adjustment
	4. Check O2 sensor reading
Engine spits & sputters	1. Check O2 sensor reading
	2. Check ignition calibration and firing order
ECU won't communicate to PC	1. Ensure your software version is compatible with your FT500 firmware version
	2. Check if read and write buttons get colored when FT500 is connected

The logo for FuelTech is presented in a stylized, italicized font with a metallic, 3D effect. The letters are white with grey shading and a red outline. The logo is set against a solid red rectangular background that spans the width of the page.

FuelTech

455 Wilbanks Dr.
Ball Ground, GA, 30107, USA

Phone: +1 678-493-**FUEL**
+1 678-493-3835

Toll Free: +1 855-595-**FUEL**
+1 855-595-3835

Email: info@fueltech.net
www.FuelTech.net